

\$ Saver Product Line

- ◆ 40 dB QMA Monitor Tap
- ◆ 7-16 DIN or N (m-f) through ports
- ◆ Low specified PIM
- ◆ 500/300 W Avg Power Rating
- ◆ Minimal RF Insertion Loss
- ◆ RoHS compliant
- ◆ High Reliability, IP65



DN-99NQ - Model shown



Microlab DN-99 Tappers allow monitoring of Tx signals with minimal reflections or loss over the wireless bands in the range 698 - 2,700 MHz. The -40 dB QMA monitor port permits test signal access with minimal insertion loss.

The lightweight design allows easy attachment to an in-line circuit. Economically designed while providing optimum PIM and RF performance. (12/14)

Specifications:

Frequency:	698 - 2,700 MHz
Coupling:	40 +3/-1 dB (698 - 800 MHz) 40 ±2 dB (800 - 2700 MHz)
Insertion Loss:	<0.2 dB
Return Loss:	>23 dB
Peak Power:	3 kW
Impedance:	50Ω nominal
Intermod. (PIM):	<-160 dBc @ 2 x 20W
Environment:	IP65, -35°C to +85°C
Monitor Port:	QMA (f)
Housing Finish:	Passivated Aluminum
Weight, nom:	7.1 oz (200 g)

Model #	Connectors (Main Line)	Power Rating (CW Avg.)
DN-99DQ	7-16 DIN (m-f)	500 W
DN-99NQ	N-type (m-f)	300 W

DN-99NQ Outline

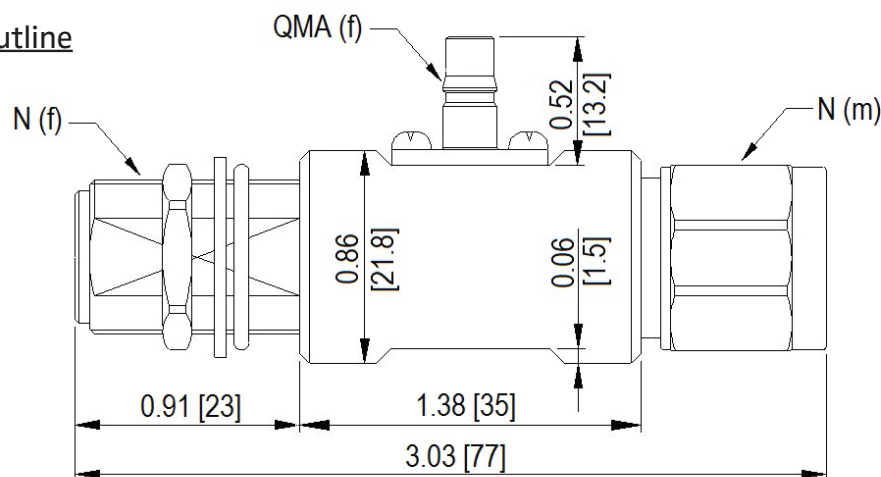

Dimension in inches [mm]

40 dB QMA Tapper, DN-99 Series

Multi-Band Signal Sampler

698-2700 MHz

Page 2

DN-99DQ Outline

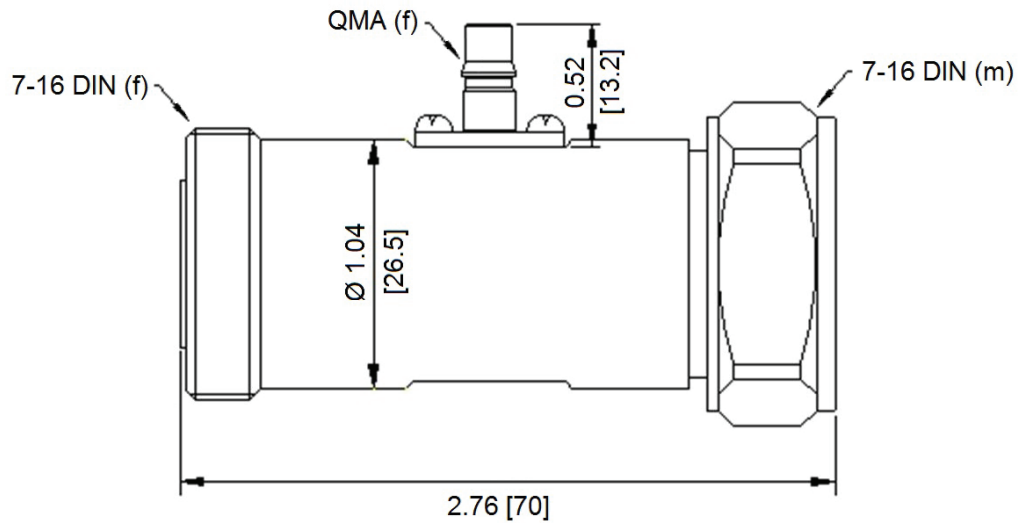

Dimension in inches [mm]